

A69.54.V5

BENCH MOUNTED SOAP DISPENSER

1. Cut out hole 22 - 25mm in bench top
2. Remove 1/2" Back Nut and place dispenser in bench.
3. Tighten Nut from underneath bench.
4. Fill bottle with liquid soap.
5. Screw bottle to 1/2" BSP thread.
6. Slowly pump air out of the dispenser until air is purged out and soap comes through. Once the dispenser is primed it will not need to be primed again unless the soap is allowed to run out completely.
7. To refill, remove bottle from underneath bench, fill and replace.

Liquid Soap Specification

Soap Solution shall be dispensed in a liquid form and should be:

- (a) vegetable oil based;
- (b) only use PH-neutral soap. PH value 6.5 - 7.5
- (c) anhydrous soap concentration range : 10-15%;
- (d) specific gravity range: 1.0 - 1.1;
- (e) viscosity range : max 2,000cps centerpoise;
- (f) soap shall contain a humectant (anti coagulant);
- (g) soap shall be perfumed or non perfumed.
- (h) Soap Solution shall be dispensed in a liquid form (foaming not suitable) and should be

IMPORTANT: IF THE SOAP DOES NOT MEET THIS SPECIFICATION, THE WARRANTY WILL BE VOID.

Recommended Soap : Astra Walker Premium Hand & Body Soap

Note : Never use soaps with grit or abrasives in them.

Cleaning

Chrome : wipe with warm water and a mild soap.

Rinse and dry with a soft cloth.

Hose : Pump through warm water.

To ensure soap does not harden within the pump, always refill the soap dispenser before totally empty. Do not leave the dispenser or unused for any length of time without thoroughly rinsing through with hot water (70°C max). Hardened soap remaining in the dispenser may cause damage to the pump mechanism.

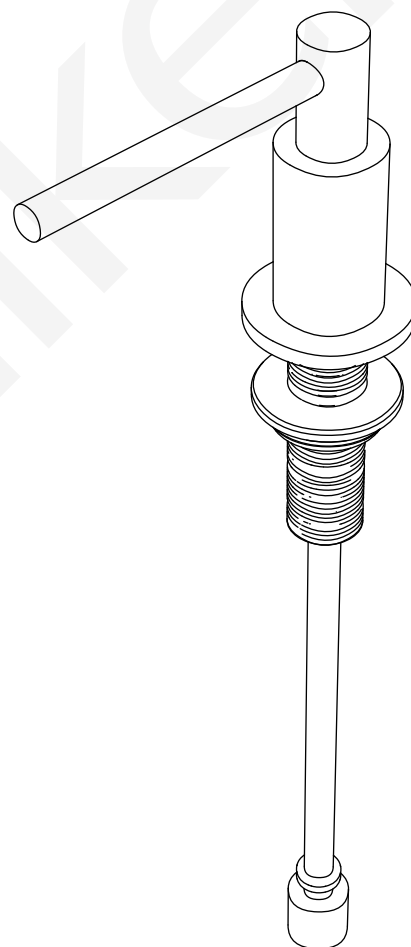

A69.54.V5

BENCH MOUNTED SOAP DISPENSER

