

A80.04

WALL SPOUT WITH CAPACITIVE SENSOR MECHANISM

6 Star 3Lpm WELS RATING

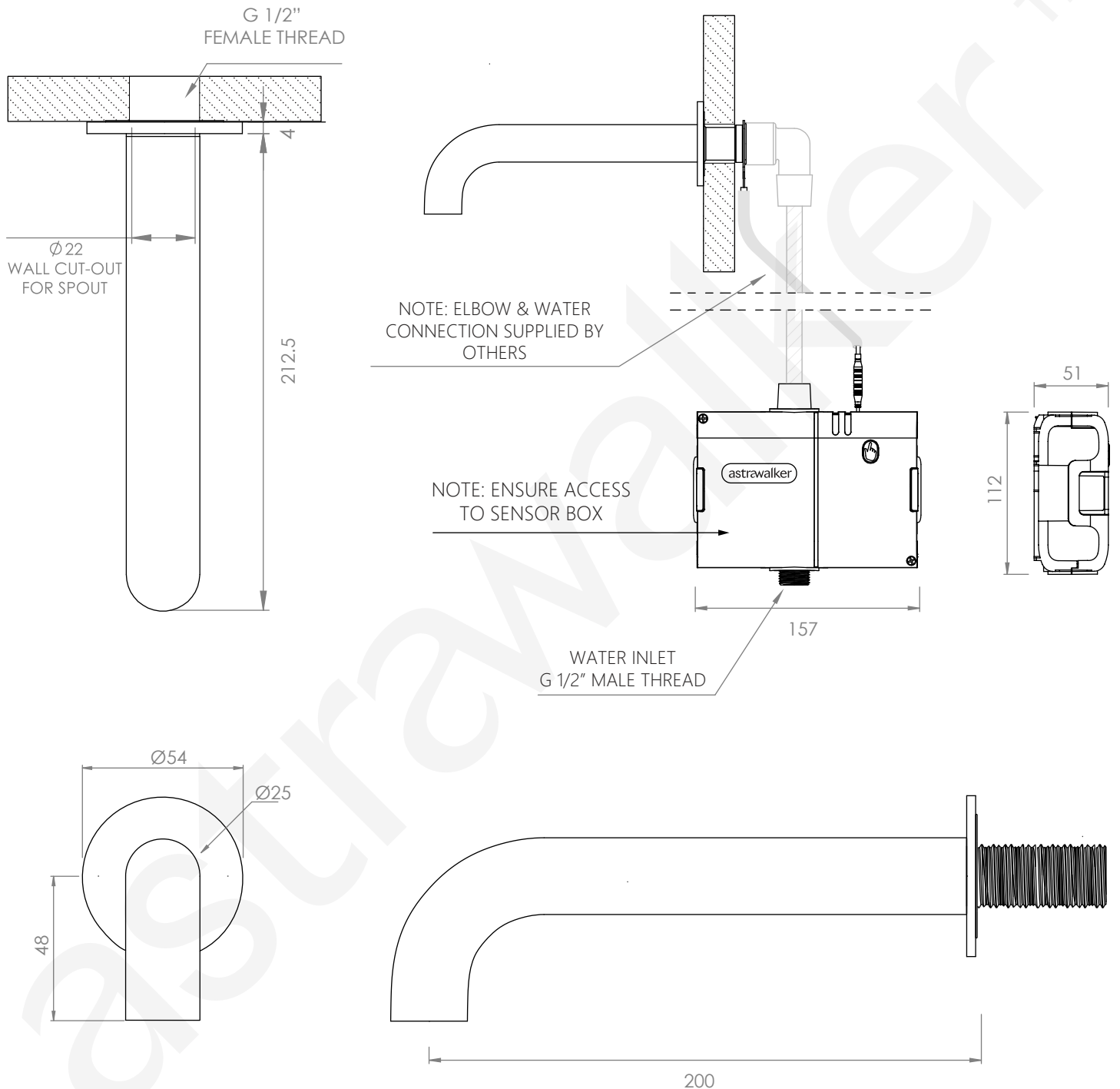

NOTE: WHEN USED WITH SECOND SENSOR SPOUT, SPOUTS MUST BE MIN 175mm APART.
NOT SUITABLE FOR USE ON CONDUCTIVE SURFACES

Head Office

215 North Rocks Road
North Rocks NSW 2151
Australia

Concept Showroom

44 Gurner Street
Paddington NSW 2021
Australia

+61 2 8838 5100
@astrawalkerofficial
www.astrawalker.com.au