

A81.05.O

WALL SET

[AVAILABLE WITH FLOW CONTROL, ADD **.FC** TO END OF CODE - 6 STAR/3.5Lpm WELS RATING]

STANDARD WITH INDENT HANDLE
OTHER HANDLE OPTIONS

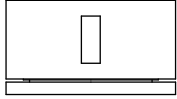
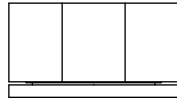

.V2 PIN HANDLE



.V3 WHITE CARRARA MARBLE
.V4 BLACK MARQUINA MARBLE

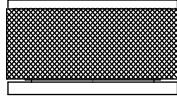

.V5 KNURLED

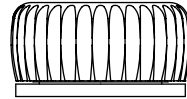

.V6 REEDED

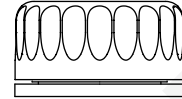

.V7 FLUTED

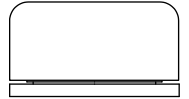

.V8 ROUND DIAL

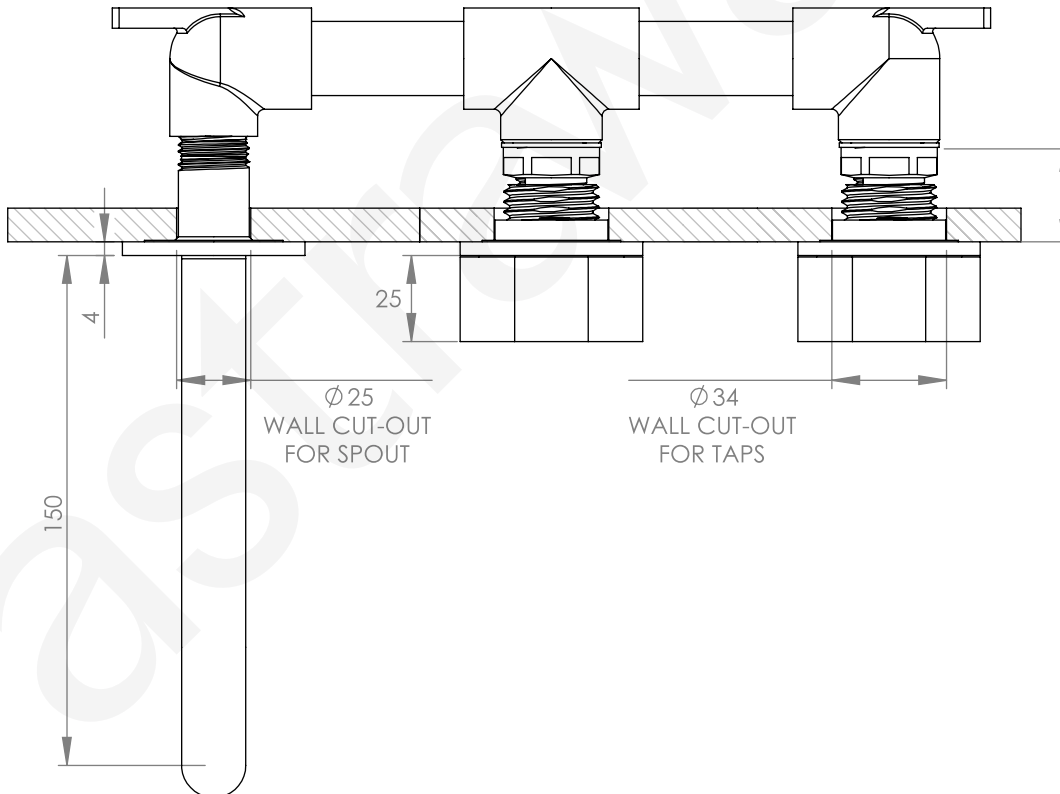
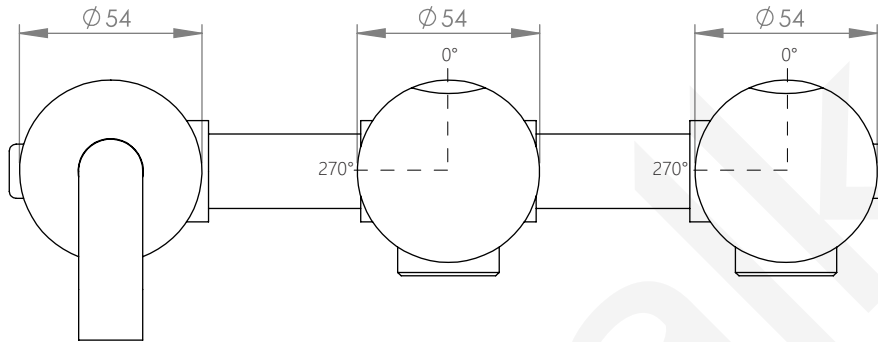

27 MAX-13 MIN
IMPORTANT : Front face of
breach to finished
wall face must be minimum
13mm to maximum 27mm

NOTE : Seat of Breach Body extensions are NOT recommended in conjunction with this Tapware. Failure to adhere will void warranty.